

# THE SANDBOX

**Play. Create. Own. Govern. Earn.**

## **Welcome to the Metaverse**

The Sandbox team is building a unique virtual world where players can build, own, and monetize their gaming experiences using SAND, the main utility token of the platform.

*SAND holders will be also able to participate in governance of the platform via a Decentralized Autonomous Organization (DAO), where they can exercise voting rights on key decisions of The Sandbox ecosystem. As a player, you can create digital assets (Non-Fungible Tokens, aka NFTs), upload them to the marketplace, and drag-and-drop them to create game experiences with The Sandbox Game Maker. The Sandbox has secured over 50 partnerships including Atari, Crypto Kitties, and Shaun the Sheep to build a fun, creative “play-to-earn” Gaming platform, owned and made by players. The Sandbox aims to bring blockchain into mainstream gaming, attracting both crypto and non-crypto game enthusiasts by offering the advantages of true-ownership, digital scarcity, monetization capabilities, and interoperability*



# DISCLAIMER

**The information in this White Paper is subject to change or update and should not be construed as a commitment, promise or guarantee by The Sandbox or any other individual or organisation mentioned in this white paper relating to the future availability of services related to the use of the tokens or to their future performance or value.**

The document does not constitute an offer or solicitation to sell shares or securities. It does not constitute or form part of and should not be construed as any offer for sale or subscription of or any invitation to buy or subscribe for any securities not should it or any part of it form the basis of or be relied upon in any connection with any contract or commitment whatsoever. The Sandbox expressly disclaims any and all responsibility for any direct or consequential loss or damage of any kind whatsoever arising directly or indirectly from reliance on any information contained in the white paper, any error, omission or inaccuracy in any such information or any action resulting therefrom.

This is not a recommendation to buy or financial advice, It is strictly informational. Do not trade or invest in any tokens, companies or entities based solely upon this information. Any investment involves substantial risks, including, but not limited to, pricing volatility, inadequate liquidity, and the potential complete loss of principal. Investors should conduct independent due diligence, with assistance from professional financial, legal and tax experts, on topics discussed in this document and develop a stand-alone judgment of the relevant markets prior to making any investment decision.

We have prepared all information herein from sources we believe to be accurate and reliable. However, such information is presented “as is,” without warranty of any kind – whether expressed or implied. All market prices, data and other information are not warranted as to completeness or accuracy, are based upon selected public market data, reflect prevailing conditions, and our view as of this date, all of which are accordingly subject to change without notice. The graphs, charts and other visual aids are provided for informational purposes only. None of these graphs, charts or visual aids can and of themselves be used to make investment decisions. No representation is made that these will assist any person in making investment decisions and no graph, chart or other visual aid can capture all factors and variables required in making such decisions.

The information contained in this document may include, or incorporate by reference, forward-looking statements, which would include any statements that are not statements of historical fact. No representations or warranties are made as to the accuracy of such forward-looking statements. Any projections, forecasts and estimates contained in this document are necessarily speculative in nature and are based upon certain assumptions. These forward-looking statements may turn out to be wrong and can be affected by inaccurate assumptions or by known or unknown risks, uncertainties and other factors, most of which are beyond control. It can be expected that some or all of such forward-looking assumptions will not materialize or will vary significantly from actual results.

## Abbreviations

<b>AML/CFT</b>	Anti-Money Laundering and Combating the Funding of Terrorism
<b>API</b>	Application Programming Interface
<b>DLT</b>	Distributed Ledger Technology
<b>IP</b>	Intellectual Property
<b>IPO</b>	Initial Public Offering
<b>MAU</b>	Monthly Active Users
<b>ML/FT</b>	Money Laundering and Funding of Terrorism
<b>NFT</b>	Non-Fungible Token
<b>P2P</b>	Peer-to-peer
<b>TSB</b>	The Sandbox
<b>UGC</b>	User Generated Content

# Table of Contents

<b>DISCLAIMER</b>	2
<b>Abbreviations</b>	3
<b>Table of Contents</b>	4
<b>Executive Summary</b>	6
A User-Generated Content Ecosystem	7
Blockchain Gaming with NFTs	8
What is SAND and what is it used for?	8
What do we plan next?	9
Associated challenges and risks	10
<b>Historical Background</b>	11
<b>The Sandbox Platform</b>	12
Mission	12
Game Overview	12
LAND and the LANDS Map	13
Avatar	17
SAND	17
SAND Stakeholders	17
SAND Revenue Streams	17
Benefits	17
<b>Market Overview</b>	18
Gaming Creator Market	19
Creator Market	20
Player Market	21
Market Solution	21
<b>Roadmap</b>	21
Previous Milestones	21
Future Milestones	23
Major Features in the Press	25
<b>Platform</b>	26

Gameplay Experience	26
Map - LANDS	28
ASSETS Marketplace	28
VoxEdit	29
<b>Economy</b>	30
Tokenomics	31
Project Financing and Initial Revenue	34
Initial Exchange Offering	34
Other Dynamics	35
<b>Technology</b>	36
Future Technology Integrations	36
Multiple Class Fungible Token (MCFT)	37
Interoperability	37
Meta Transactions	38
Technology Solution Breakdown	38
Program Agents	39
Game Engine	40
Wallets	41
Security	41
<b>The Team</b>	42
Core Team	42
Advisors	43
Services Providers	43
<b>CONCLUSION</b>	44

# The Whitepaper

## 1. Executive Summary



The Sandbox is a virtual world where players can build, own, and monetize their gaming experiences in the Ethereum blockchain using SAND, the platform's utility token.

Our vision is to offer a deeply immersive metaverse in which players will create virtual worlds and games collaboratively and without central authority. We are aiming to disrupt the existing game makers like Minecraft and Roblox by providing creators true ownership of their creations as non-fungible tokens (NFTs) and rewarding their participation with our utility token – SAND.

In the current game market, the centralized ownership and control of user-generated content limits creator rights and ownership. Central control over the trading of virtual goods created by players restricts them from generating fair value for their creations. Compounding this, it can be difficult to prove creative ownership of works, especially as content is copied, altered, and built upon.

With The Sandbox, we aim to overcome these limitations while accelerating blockchain adoption to grow the blockchain gaming market. We will do this by building a voxel gaming platform where creators are able to craft, play, share, collect, and trade without central control, enjoying secure copyright ownership with the ability to earn cryptocurrency (SAND). This copyright ownership will be established and guaranteed through the use of NFTs, where every in-game item will have a unique and immutable blockchain identifier.

## 1.1. A User-Generated Content Ecosystem

The Sandbox gaming ecosystem consists of three integrated products that together provide a comprehensive experience for user-generated content (UGC) content production.



- A. **VOXEDIT:** This simple to use yet powerful free 3D voxel modelling package allows users to create and animate 3D objects such as people, animals, foliage, and tools, and export them into The Sandbox marketplace to become game ASSETS.
- B. **MARKETPLACE:** The Sandbox's web-based marketplace allows users to upload, publish, and sell their creations (ASSETS) made in VoxEdit, as Tokens (Both ERC-721 and ERC-1155 tokens).
- C. **GAME MAKER:** Anyone who owns ASSETS, either by making them in VoxEdit or purchasing them, can utilize them with the third and most important ecosystem product, the Game Maker and the Game itself. This product, when launched in Game Maker mode, enables users to place and use their ASSETS within a piece of LAND (an ERC-721 token) that they can own in the virtual world. Users can decorate their LAND with ASSETS, and more importantly, implement interesting and nuanced gameplay mechanics by assigning predefined behaviors to the ASSETS through visual scripting nodes, turning a LAND from a decoration experience into a potential full game experience.

## 1.2. Blockchain Gaming with NFTs

The Sandbox virtual world uses blockchain technology and NFTs to empower the players and creators. NFTs are an emerging segment in the global game market: virtual tokens for digital scarcity, security and authenticity. Each NFT is distinct or unique, it is indivisible and it is not interchangeable for another.

Fungible	Non-fungible
E.g., One US Dollar	E.g., John Lennon Limited Edition Postage Stamps
Interchangeable	Not interchangeable
Uniform (all are the same)	Distinct or unique
Divisible	Indivisible

*Comparison of Fungible versus Non-fungible Tokens*

Through the use of NFTs, The Sandbox users will be able to benefit from:

- A. **TRUE DIGITAL OWNERSHIP:** Gamers are the true and perpetual owners of their digital items, even if the game was shut down or abandoned. With blockchain, every game item can be tokenized, allowing gamers to decide how they want to trade, sell, or gift their items.
- D. **SECURITY AND IMMUTABILITY:** Digital game items can be easily tokenized and traded in primary and secondary markets that are managed and facilitated by blockchain technology. Items based on scarcity and demand usually invite fraud and theft, but these risks are minimised on blockchain because it is a distributed ledger.
- E. **TRADING:** Blockchain-based gaming platforms can provide users with ultimate control over their digital assets. They can buy and sell items freely without concern that they will be ripped off or that a platform will close and cancel all the value of their in-game items.
- F. **CROSS-APPLICATION INTEROPERABILITY:** Blockchain provides capacity for games to utilize shared assets. ASSETS, avatars, LANDS and any other game elements can be used in other games that allow it. These game items are no longer confined by a narrow digital ecosystem.

The Sandbox metaverse uses several tokens to create a circular economy between all the profiles of users who will interact with its platform namely the players, creators, curators and LAND owners. These are the LANDS, ASSETS and SAND, a token based on the ERC20 protocol which will act as the official currency in the ecosystem when purchasing goods and services within the game marketplace (amongst other rights).

## 1.3. What is SAND and what is it used for?



SAND is an essential part of The Sandbox platform and The Sandbox are working on establishing key mechanics that makes it intrinsically tied to The Sandbox platform and its value. SAND is an ERC-20 utility token built on the Ethereum blockchain that serves as the basis for transactions within The Sandbox, and has the following uses:

- **Access The Sandbox platform:** Players spend SAND in order to play games, buy equipment, or customize their Avatar character—and can potentially collect SAND through gameplay. Creators spend SAND to acquire ASSETS, LANDS, and through Staking. LAND Sales drive demand for SAND to purchase LANDS. Artists spend SAND to upload ASSETS to the Marketplace and buy Gems for defining Rarity and Scarcity.
- **Governance:** SAND is a governance token that allows holders to participate in Governance decisions of the platform, using a DAO structure. They can exercise voting rights on key elements such as Foundation grant attributions to content and game creators and feature prioritisation on the platform Roadmap. SAND owners can vote themselves or delegate voting rights to other players of their choice.
- **Staking:** SAND allows for staking, which allows for passive revenues on LANDS: you get more SAND by staking it. This is also the only way to get valuable Gems and Catalysts, needed for ASSET creation.
- **Fee Capture model** = 5% of all transaction volume carried out in SAND tokens (Transaction Fees) shall be allocated with 50% to the Staking Pool as rewards for token holders that Stake SAND tokens and 50% to the "Foundation."
- **Foundation:** The role of the Foundation is to support the ecosystem of The Sandbox, offering grants to incentivize high quality content & game production on the platform. To date, the Foundation has funded over 15 game projects and granted 100 artists to produce NFTs ahead of the public Launch in December 2020. The overall valuation of the metaverse grows through the valuation of all games funded by the Foundation, creating a virtuous circle to enable funding bigger games.

## 1.4. What do we plan next?

We have a strong product roadmap ahead and a top team to execute a strong vision to build a unique virtual world gaming platform where players can build, own, and monetize their gaming experiences and spread the power of blockchain as the lead technology in the gaming industry. All these together with what we have achieved so far resulted in TSB being awarded a recognition as the most expected blockchain game in 2020.

<https://www.blockchaingamer.biz/news/12585/blockchain-game-sentiment-positive-the-sandbox-most-anticipated/>

In the short term, we are launching the fourth LAND presale and Game Maker. This will be complemented with the SAND public launch. As such, we expect to have SAND available for individuals and corporations in order to increase liquidity and availability of it with the main purpose to collaborate with the community growth and ecosystem flow.

In relation to the proposed SAND offering, the community of creators and players will need to get access to SAND. We plan to make it accessible to the community through multiple ways with controllable supply mechanisms, such as purchasing SAND from multiple exchanges.

As the community increases in terms of the number of creators, players and ASSETS exchanged in the marketplace, there might be an increased need for SAND within the ecosystem. Therefore, while the total supply of SAND is fixed, the initial amount of SAND offered will provide a scarcity effect reducing the SAND available per capita and therefore fostering demand.

## 1.5. Associated challenges and risks

It is the responsibility of any purchaser of SAND to inform themselves of, and to observe and comply with, all applicable laws and regulations of any relevant jurisdiction. Prospective purchasers for any SAND shall be expected to consider the risk factors identified in this section. If any of the indicated risks were to materialize, then they could have a negative impact on the Issuer's finances and operational performance which can hinder the ability of the Issuer to fulfil its obligations under this whitepaper.

The challenges and risks are identified by the board of administration of the Issuer as at the date of registration of this whitepaper. This does not exclude the possibility of there being other risk threats and the purchaser must be aware that the impact on the Issuer may be heightened due to a combination of several risks materializing simultaneously.

One of the main challenges in the project is the rate of adoption of the community of artists and creators to start exchanging assets, which will be a key point behind the demand generation of SAND. As such, we are focused in developing a strong, multi-platform product that can spread massively by offering a tool to create voxel art that is focused on solving problems and community needs. We are therefore developing strong communities in different areas of the world with a strong focus in Asia, where we believe the rate of adoption and learning curve will be steeper. The project success rate will be dependent upon the priority and preference of consumers and its ability to swiftly anticipate, identify and capitalise upon these priorities and preferences.

The Issuer operates in an emerging and disruptive industry that is under rapid and dynamic development. This includes, but is not limited to, the developments relating to the business itself, the underlying technology, and the regulatory and legal implications thereof. Specifically, in relation to public knowledge and understanding of emerging technologies, such distributed ledger technologies, smart contracts and other innovative technology arrangements, are still limited as at the date of registration of this whitepaper. The risks arising out of such may not be fully comprehended as of yet and new additional risks may arise in the future.

As the Issuer's undertaking is reliant on the continuous and proper functioning of its technology infrastructure, the Issuer is subject to a variety of risks relating to the proper maintenance thereof. These risks include, but are not limited to, cyber-attacks, data theft or other unauthorised use of data, and other malicious interferences. Certain parts of the infrastructure may be outsourced to third parties. In such

cases, the Issuer is reliant upon technology arrangements developed by such third parties for the running of its undertaking, and it is exposed to the risk of failures in such technology arrangements.

The Issuer is subject to various laws, including regulations and rules issued thereunder, and is at risk in relation to changes in the laws and the timing and effects of changes in the respective legislation. This includes changes in the interpretation thereof which cannot be predicted by the Issuer.

The growth of the Issuer and its undertaking is partially attributable to the efforts and abilities of the members of its management team and other key personnel, particularly its board of administration. If one or more of the members of this team were unable or unwilling to continue in their present position, the Issuer might not be able to replace them within a short time, which could in turn have a material adverse effect on the Issuer’s business.

## 2. Historical Background

The Sandbox is the latest version of The Sandbox franchise, which has helped create the sandbox world creation games genre on iOS and Android smartphones since its launch in 2012:

- 40,000,000 players have downloaded The Sandbox franchise;
- The latest iteration, The Sandbox Evolution, has over 1,200,000 MAUs, with up to 2,600,000 at peak;
- 70,000,000 worlds have been created; and
- Over 100,000 worlds are created every day.

**2012-2018**

We're leveraging our most successful IP, a large community of creators and **7 years of expertise in User-Generated Content**

**40M** INSTALLS ON IOS & ANDROID

**70M** WORLDS CREATED BY OUR COMMUNITY SINCE 2012

**2019-2020**

**Most Anticipated Blockchain Game of 2019**

Source: BCG.BIZ (August 13th, 2019) <https://www.blockchaingamer.biz/news/12585/blockchain-game-sentiment-positive-the-sandbox-most-anticipated/>

**#13 Top Blockchain Games Companies of 2020**

Source: BCG.BIZ (January 22nd, 2020) <https://www.blockchaingamer.biz/features/13597/top-50-blockchain-game-companies-2020/>

The new blockchain-based version of The Sandbox has already received several awards:

- Voted the most anticipated blockchain game of 2019/2020 by BlockchainGamer.biz - <https://www.blockchaingamer.biz/news/12585/blockchain-game-sentiment-positive-the-sandbox-most-anticipated/>

[sandbox-most-anticipated/](#)

- Ranked #13 in the Top 50 Blockchain Games Companies of 2020 Report by DappRadar.com - <https://www.blockchaingamer.biz/features/13597/top-50-blockchain-game-companies-2020/>

The Sandbox combines the large, active and enthusiastic franchise audience with a richer gaming environment based on a new 3D voxel<sup>1</sup> engine, and the revolutionary ability of blockchain integration with NFTs<sup>2</sup> to offer players creative and financial control of the content they make.

## 3. The Sandbox Platform

### 3.1. Mission

The Sandbox team's mission is to build a system where creators will be able to craft, play, share, and trade without central control, enjoying secure copyright ownership with the ability to earn SAND.

The Sandbox team believes these innovations are important, for while the current market for voxel-based creation games already has 500,000,000 Creators and 160,000,000 MAUs, it suffers from four key problems that could hinder future growth if not addressed:

- The centralization of user-generated content in dominant titles such as Minecraft and Roblox limits creator rights and ownership;
- Central control over the trading of virtual goods created by players restricts players from generating fair value for their creations, limiting what they can or cannot sell and/or taking a significant portion of the sales revenue;
- Given the nature of voxel art, it can be difficult to prove creative ownership of works, especially as content is copied, altered and built upon; and
- Existing game marketplaces are based on fiat currencies, which do not support true microtransactions and are vulnerable to credit card fraud that can unbalance in-game economies.

### 3.2. Game Overview

---

<sup>1</sup> Voxels, or volume pixels, are analogous to 3D pixels, with each voxel representing a value on a defined grid in three-dimensional space

<sup>2</sup> Non-fungible items are unique and cannot be replaced by another equal part or quantity, as explained in this article: <https://medium.com/crypto-currently/the-anatomy-of-erc721-e9db77abfc24>

At its core, The Sandbox is an ecosystem for Players and Creators, consisting of three main components: a Voxel Editor (named “VoxEdit”), a Marketplace, and the Game itself.

The Sandbox offers a unique way to create, assemble, and share 3D voxel models. We empower Creators with intuitive, powerful content creation tools. You can make your own 3D voxel objects, animate them, and publish/sell them in our worldwide marketplace. VoxEdit is our 3D tool that allows anyone to create or import their own voxel objects, work on them, and effortlessly export them to the marketplace where users can turn them into limited ERC-1155 tokens called ASSETS. ASSETS are virtual tokens for digital scarcity, security and authenticity. They are unique/limited as well as distinct and indivisible.

Blockchain allows creators to have true ownership and thanks to this technology we, in our capacity as developers, can finally reward players for their time and the hard work they put into content creation, allowing them to monetize and freely trade their ASSETS.

Our ASSET smart contract allows content to become the new platform, creating a new paradigm. This is because they offer multiple uses and are not confined to a single game. This "second-layer programmability" gives any developer the power to bring a lasting and ever-growing value to the ASSETS, which can be shared cross-games, cross-platforms and cross-chains.

The Marketplace is the trading environment for ASSETS, where they can be given away for free or sold to other PLAYERS.

The Game is the overall game system where playable experiences can be enjoyed and shared. In the Game, not only can creators profit from their creations, players can play-to-earn by collecting resources, rewards, and tokens.

### **3.3. LAND and the LANDS Map**

LANDS are blockchain-backed virtual tokens (using the ERC-721 standard for NFTs) representing physical parcels of The Sandbox Metaverse. They allow players to own a portion of the Metaverse and thus be able to host content (ASSETS and GAMES).

The Sandbox Metaverse is based on a map of 166,464 LANDS (408\*408). LANDS are physical spaces in the Metaverse owned by players to create and monetize Games. LANDS are used to publish your game and can be rented to game creators. Every LAND comes with a set of prebuilt terrains, but it can be terraformed and modified by the USER who owns it (or other PLAYERS they invite to work on it).

In the future, players will be able to combine LANDS together to form ESTATES. In the future, ESTATES will have the potential to be owned by multiple players to form DISTRICTS.

### **3.4. Avatar**

An AVATAR is an in-game voxel representation of a player, which may be modified piece by piece by the owner. An avatar has certain specifications and format and comes with a default set of animations such

as walking, running, jumping and fighting. Specifically, this avatar will be modifiable piece by piece (helmet, arms, torso, legs, etc.) by equipping it with different compatible ASSET tokens.

### 3.5. SAND

SAND is an essential part of The Sandbox platform and we are working on establishing key mechanics that makes it intrinsically tied to The Sandbox platform and its value. SAND is an ERC-20 utility token built on the Ethereum blockchain that serves as the basis for transactions within The Sandbox, and has the following uses:

- Access The Sandbox platform: Players spend SAND in order to play games, buy equipment, or customize their Avatar character. Creators spend SAND to acquire ASSETS, LANDS, and through Staking. LAND Sales drive demand for SAND to purchase LANDS. Artists spend SAND to upload ASSETS to the Marketplace and buy Gems for defining Rarity and Scarcity.
- Governance: SAND is a governance token that allows holders to participate in Governance decisions of the platform, using a DAO structure. They can exercise voting rights on key elements such as Foundation grant attributions to content and game creators and feature prioritisation on the platform Roadmap. SAND owners can vote themselves or delegate voting rights to other players of their choice.
- Staking: SAND allows for staking, which allows for passive revenues on LANDS: you get more SAND by staking it. This is also the only way to get valuable Gems and Catalysts, needed for ASSET creation
- Fee Capture model = 5% of all transaction volume carried out in SAND tokens (Transaction Fees) shall be allocated with 50% to the Staking Pool as rewards for token holders that Stake SAND tokens and 50% to the "Foundation."
- Foundation: The role of the Foundation is to support the ecosystem of The Sandbox, offering grants to incentivize high quality content & game production on the platform. To date, the Foundation has funded over 15 game projects and granted 100 artists to produce NFTs ahead of the public Launch in December 2020. The overall valuation of the metaverse grows through the valuation of all games funded by the Foundation, creating a virtuous circle to enable funding bigger games.

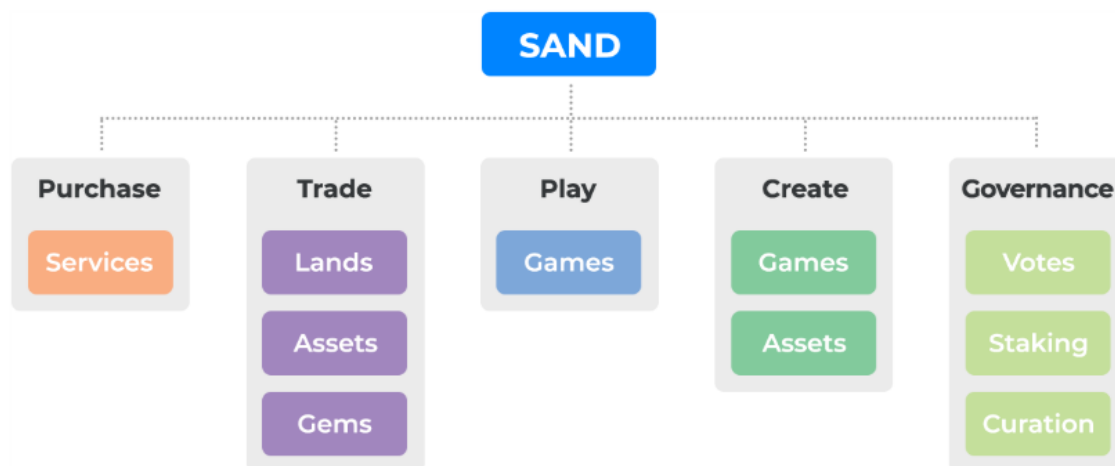

Figure: The Use Case for SAND

### 3.6. SAND Stakeholders

We have developed a 4 Stakeholders approach to ensure that the success of TSB. Therefore, we will set through smart contracts, that revenues generated through The Sandbox will be distributed across 4 stakeholders to provide support to the ecosystems of creators and players as well as to provide the resources needed to grow the market and develop high quality gaming experiences.

These 4 stakeholders are:

1. **Foundation Pool:** Is designed to ensure that revenue generated through the game is redistributed to support the growth of the ecosystem. The token allocation of this Foundation pool will be progressively decentralised as we implement a DAO/Community driven solution towards a decentralized model for the benefit of the token ecosystem.
2. **Staking Pool:** Is designed to provide incentives to token holders who are actively locking their funds in smart contracts. Its governance will migrate from a centralized decision on year 1 towards a DAO mechanism in the coming years. Token holders that are also active players will generate an extra yield rewarding their activity.
3. **Company Treasury:** This represents the SAND that is owned by the company that comes from the proceeds of sales of company owned assets with a 12 months lock-up. The SAND generated through this Treasury will be sold back to the market to pay operational expenses.
4. **Company Reserve:** This is the initial company reserve of 600mm SAND (20% of total Token Supply). This reserve will be fed with the proceeds of sales of company owned assets with a 6 month lock-up.

### 3.7. SAND Revenue Streams

TSB has 5 Revenue Streams where players/creators will exchange SAND. That SAND will be allocated as detailed below:	
(1) LAND Sales	50% locked for 12 months then being sold in auction sales and proceeds go to the Company's Treasury;
(2) Company NFTs Sales	25% transferred to the Company Reserve with a lock-up period of 6 months;
(3) Player Subscriptions & Services	25% transferred to the "Foundation" to support the growth of the token ecosystem
(4) Transaction Fees = 5% any SAND trx	Transaction Fees to be restructured as 5% of all transaction volume carried out in SAND tokens, including but not limited to SAND transactions related to sales and rental transactions of LAND (from TSB to players and from players to players in marketplace), NFT transactions (from TSB to players and players to players in marketplace), peer-to-peer in-game payments (e.g., entrance fees for game experiences), player subscription fees and advertising fees
	50% allocated to the Staking Pool as rewards for token holders that Stake SAND tokens;
	50% of all Transaction Fees shall be allocated to the "Foundation"
(5) Advertising Revenue	25% allocated to the Staking Pool as rewards for token holders
	75% allocated to the "Foundation"



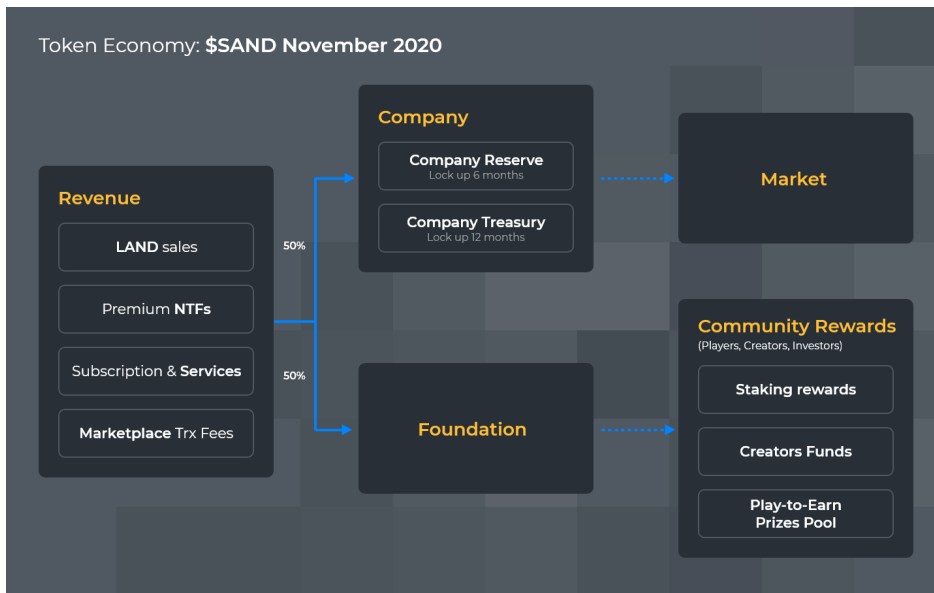

Figure: The Flows of SAND

### 3.8. Benefits

The creation of a decentralized blockchain based gaming platform provides multiple benefits when compared to current, non-blockchain systems, as illustrated in the chart below:



With Blockchain (The Sandbox)	Without Blockchain (Roblox & Minecraft)
<p><b>True Ownership</b></p> <ul style="list-style-type: none"> <li>● Assets stored in player wallets through tokenization of UGC;</li> <li>● User retention of copyright in perpetuity;</li> <li>● Ownership not tied to a game; and</li> <li>● Creative authorship is immutable.</li> </ul>	<p><b>Limited Ownership</b></p> <ul style="list-style-type: none"> <li>● Assets stored in game systems;</li> <li>● Copyright limited and items can be modified by third parties;</li> <li>● Ownership is tied to the game; and</li> <li>● Creative authorship is hard to prove.</li> </ul>

<p><b>Secure</b></p> <ul style="list-style-type: none"> <li>• Less fraud possibility thanks to blockchain’s record keeping technology.</li> </ul>	<p><b>Insecure</b></p> <ul style="list-style-type: none"> <li>• Server-based transactions; and</li> <li>• High possibility of fraud (13% average).</li> </ul>
<p><b>Fair Revenue Share</b></p> <ul style="list-style-type: none"> <li>• Creators will receive 100% of the selling price they set for their creations; and</li> <li>• Multiple creators can automatically share payments and revenue.</li> </ul>	<p><b>Limited Revenue Share</b></p> <ul style="list-style-type: none"> <li>• Creators receive partial payment for items they sell; and</li> <li>• Ownership limited to one player entity.</li> </ul>
<p><b>Decentralized Trading</b></p> <ul style="list-style-type: none"> <li>• Blockchain allows assets to be shared between users for collaboration; and</li> <li>• Peer-to-peer trading</li> </ul>	<p><b>Centralized Trading</b></p> <ul style="list-style-type: none"> <li>• Centralized system limits collaboration; and</li> <li>• All trades are controlled by 3rd parties.</li> </ul>

## 4. Market Overview

The current gaming market presents favorable conditions that offer The Sandbox a unique opportunity to exploit on both PC/Mac and mobile platforms, as the opportunity to shift power and earning potential into the hands of players in the growing UGC gaming market will add significant value to their gameplay experience.

- The global gaming market is expected to reach: USD 171.96 billion<sup>3</sup> by 2025;
- The mobile segment, which is one of The Sandbox’s target platforms, is projected to gain momentum and exhibit a compounded annual growth rate (CAGR) of 7.3% over the coming years, owing to increasing smartphone penetration across the globe<sup>4</sup>;
- The online segment is estimated to witness substantial growth over the next eight years, expanding at a CAGR of 8.6% from 2020 to 2025. This can be attributed to increasing broadband penetration and growing online betting, gambling, and social network gaming<sup>5</sup>; and
- The Asia Pacific market is expected to gain traction, attaining a market size of USD 86.84 billion by 2025. Emerging countries such as China, India and South Korea are offering lucrative growth opportunities for market augmentation, which can be partly attributed to growing smartphone and Internet penetration in these countries.

<sup>3</sup> <https://www.grandviewresearch.com/press-release/global-gaming-market>

<sup>4</sup> <https://newzoo.com/insights/articles/the-global-games-market-will-reach-108-9-billion-in-2017-with-mobile-taking-42/>

<sup>5</sup> <https://prnewswire.com/news-releases/gaming-market-size-worth-17196-billion-by-2025--cagr-65-grand-view-research-inc-671617663.html>

## 4.1. Gaming Creator Market

The Sandbox team's mission is to build a system where creators will be able to craft, play, share, and trade without central control, enjoying secure copyright ownership with the ability to earn SAND.

The genre of creator games with voxel graphics is dominated by two key industry players, Minecraft and Roblox. Minecraft, the leader in the category, saw player numbers grow over 30% year on year for the last five years, while Roblox placed sixth in the list of top grossing iPhone mobile gaming apps in the United States as of January 2018, ranked by daily revenue. Roblox is estimated to take in over USD 750,000 per day in revenue. Some creators have reportedly earned over USD 30,000,000<sup>6</sup> in 2017 from the 70%<sup>7</sup> revenue share they receive from sales inside their own creations.

Both games are now available on a variety of platforms including PC, mobile and console. A few numbers show the scope of the market in tangible terms:

### Minecraft

- Over 100,000,000 MAU in 2019, up 74,000,000 from 2017<sup>8</sup>;
- Over 144,000,000 copies sold worldwide;
- In 2014, Microsoft purchased the Minecraft franchise for USD 2.5 billion; and
- The purchase price equates to roughly USD 17 per copy sold when averaged across all units.

### Roblox

- Had 100,000,000 MAU in 2020<sup>9</sup>;
- Raised USD 150,000,000 series G on a USD 5 billion valuation in February 2020;
- 11,000,000 game titles were published in the Roblox world in 2017<sup>10</sup>;
- Over 1,500 titles have each generated over 1,000,000 user visits from other players; and
- Meep City, which was published in Roblox in February 2016, was the first Roblox game to surpass 1 billion player visits.

### The Sandbox Evolution

- Had 1,200,000 MAUs in 2018; and
- Over 70,000,000 creations made inside the game by its users.

---

<sup>6</sup> <https://www.forbes.com/sites/alexknapp/2018/03/21/young-developers-earned-over-30m-on-roblox-in-2017-the-gaming-site-kids-visit-more-than-youtube/#e490ac860942>

<sup>7</sup> <https://www.roblox.com/premium/membership?cashout=obc>

<sup>8</sup> <https://www.engadget.com/2019/09/15/minecraft-112-million-monthly-players/>

<sup>9</sup> <https://techcrunch.com/2019/08/04/roblox-hits-100-million-monthly-active-users/>

<sup>10</sup> <https://www.businesswire.com/news/home/20180221005527/en/Roblox-Celebrates-Top-2017-Titles-5th-Annual>

## CryptoKitties

- Over USD 12,000,000 raised from asset sales<sup>11</sup>
- More than 1,000,000 kitties created<sup>12</sup>;
- Has approximately 500 Daily Active Users; and
- Various special themed kitties from partnerships, including the NBA<sup>13</sup>

## Platforms

- Sketchfab, one of the largest 3D creators marketplace has approximately 400-1,000 models uploaded per day;
- 100,000 3D models have been uploaded in over 700 days<sup>14</sup>; and
- TurboSquid, the world's source for professional 3D models has over 500,000 models and 3,500,000 users.

## 4.2. Creator Market

A primary challenge facing voxel art creators in the current gaming environment is they have limited or no legal rights to the intellectual property they create. This can result in artists or creators spending days or even months creating their in-game worlds while receiving little or no financial benefit.

Another hurdle facing players is establishing creative ownership of their works, especially if another player or entity copies the original work, modifies it or builds on it. Without a system for identifying and tracking the ownership of an item from first creation, it's almost impossible to tell if work is original or copied.

Lastly, the common reliance on fiat currencies and credit card transactions means the element of credit card fraud is never far away. Currently, the ratio of illegitimate transactions in games can be as high as one out of every 7.5 items sold as the result of credit card fraud, potentially disrupting the entire in-game economy.

By registering every ASSET created as an NFT, The Sandbox allows creators true ownership of everything they create. Creators retain copyright and ownership of everything they create and can sell and trade items while receiving all the benefits for their work. As transactions are made via blockchain in Ethereum, credit card fraud is eliminated. Aside from addressing all of these issues, The Sandbox aims to bring even more value to the crafted items of CREATORS. For the first time ever, CREATORS will be able to see how their uploaded ASSETS come to life when they see them used in a LAND as part of great experiences.

---

<sup>11</sup> <https://venturebeat.com/2018/03/20/cryptokitties-blockchain-sensation-raises-12-million/>

<sup>12</sup> <https://medium.com/@CryptoKitties/thanks-a-million-f422af041d0f>

<sup>13</sup> <https://www.coindesk.com/nba-superstar-steph-curry-now-first-celebrity-cryptokitty/>

<sup>14</sup> <https://sketchfab.com/100k>

### 4.3. Player Market

Issues such as ownership or compensation are of less concern to players who primarily come to games to play and buy items rather than create and sell them. However, another issue directly affects these players is that they spend real-world money to buy items in-game, but they have no way to recover this money.

For instance, if they stop playing a game, all the items they bought in it immediately become worthless. If the game is shut down for any reason, such as a decline in popularity that makes it less profitable, all the player's in-game purchases vanish into nothing. This is especially true in free-to-play (F2P) games. Purchases are a one-way street. Players spend money to buy things in the game, but have no way to recover their value if they no longer use an item, and have no way to sell it to another player legally so they receive no compensation if the game is taken off the market.

### 4.4. Market Solution

The game's player-centric innovations and improvements over current titles in the market make it probable that The Sandbox can expand its audience beyond the 40,000,000 players who have downloaded previous versions of The Sandbox and the game's current 1,200,000 MAUs.

The first stage of this process is the creation of a semi-decentralized gaming community with some elements under the central control of The Sandbox and other elements decentralized to the creators and players themselves.

## 5. Roadmap

The Sandbox has been operating since 2012, and it follows that this issue of SAND is one of the next steps in its journey towards creating this decentralized game

### 5.1. Previous Milestones

#### May 2012

- The Sandbox franchise launches on iOS.

#### February 2013

- The Sandbox is released for Android (1st title).

### March 2014

- The Sandbox surpasses 10,000,000 downloads.

### March 2015

- The Sandbox Evolution is announced at GDC conference (2nd title).

### June 2016

- The Sandbox Evolution released on iOS, Android & Steam.

### July 2017

- The Sandbox Evolution receives two big partnerships:
- Bandai Namco brings PAC-MAN to the game;
- Dreamworks brings Shrek to the game; and
- The Sandbox Evolution announced free download in Steam.

### April 2018

- The Sandbox surpasses 40,000,000 downloads and 70,000,000 player creations; and
- The Sandbox Surpasses 750,000 followers on Facebook

### 2019

- **Funding:** We have closed a seed round with a total of USD 3,410,000 raised;
- **Team:** We have assembled the right senior team to execute our vision: 42 resources located in our 3 offices with 28 FTE in Argentina, 11 in France, 2 in Korea and 1 in Japan;
- **First revenue:** The first two rounds of LANDS presale (2.5% then 5% of the total map supply) sold out in almost 1 hour — exciting success despite the bearish crypto market in December 19 then February 2020. Total Revenue generated of 1,400 ETH (approximately USD 300,000);
- **Community:** Growing with over 10,000 members on our Discord. Our NFT maker VoxEdit has been downloaded overall 65,000 times and the 100 artists forming part of our Creator's Fund have made 3,000 ASSETS already. Over 3,500 accounts on our Marketplace;
- **Smart Contracts:** All our smart contracts is available publicly on Github and has been audited by Certik, a leader in security trusted by Binance, Upbit, Bithumb, etc, We scored 93/100, among the highest in the industry;
- **Korea Presence:** Growing over 1,000 highly engaged creators and members. Officialized our partnership with SBS Seoul Game Academy (reaching out to 2,000 students on 8 campuses in Korea);

- **Japan Presence:** Started collaboration with Geekhash (a Japanese crypto-marketing agency, who is also representing Dapp.com), ran several meetups (Devcon5 Blockchain Game meetup and Tokyo Blockchain Games Meetup) and began localizing our Deck, Website and Medium articles. Opened Twitter with 600 followers and reaching 50,000 impressions per month.

#### Q1 2020

- **VoxEdit** – Launch of VoxEdit Beta Release
- **LAND Pre Sales** – Launch Rounds 2 and Round 3, selling 5% and 10% of the Map in hours

#### Q2 2020

- **Game Maker Closed Alpha** – Private release of the Game Maker Alpha to few early testers
- **LAND MoonSale** – 6 rounds of LAND sales over 5 weeks

#### Q3 2020

- **Game Maker Public Beta** – Public Release of the Game Maker Beta
- **LAND Presales** – Round 4 Opening
- **Marketplace** – SAND purchases, P2P sales, ASSET minting with Gems & Catalysts
- SAND Public Listing — Binance IEO and listing on public exchanges

## 5.2. Future Milestones

#### Q4 2020

- **Game Public Beta** – Public Beta Launch of the Games Platform, with dozens of games available to play (supported by the Foundation)
- **Events** – Launch of the First Season event with play-to-earn mechanisms
- **Multiplayer** – Socialize, Chat and Interact with friends in The Sandbox hubs
- **LAND Public sale** – Regular LAND sales and Support for Game Maker
- **VoxEdit** – Official Release 1.0

#### 2021-2023

We are aiming to become one of the leading established key players in the space of virtual worlds with blockchain-based digital LANDS, reaching over 1,000,000 MAUs over the next five years. To achieve this, we will be working on:

- **VoxEdit:** We will be working directly with communities of artists to add the extra features they are asking for and facilitate the creation of more advanced models, while keeping in mind to remain accessible to all;
- **Marketplace:** We will be working on engaging features that will be driving long term engagement and interactions with The Sandbox platform, allowing creators to work and collaborate together in teams establishing more advanced collaborative workflows, as well as features enabling any creator to run its own presale for games, organize its own contest with prize pools, define rules of each DAOs with its sub-community and more;
- **Game Maker/Player:** We will be releasing the Game Player on multiple platforms, starting with mobile (iOS and Android) in 2021 and expanding to console thereafter. We will improve the meta-gameplay to create come back design and providing incentives for players to explore and participate in the economic loop (Create, Trade, Play), fostering the Play-to-Earn (Monetize your skill and time by collecting resources, rewards, and tokens) as pillars of the economy. Players will have individual goals and objectives for the meta-gameplay but we will also include collective objectives to create communities and competition. The Sandbox LANDS can work as common hubs for players, provide different experiences, advertise & shops, chat rooms, and other featured experiences;
- **Blockchain and Tokens:** We will be opening even more our blockchain technology to other Developers (marketplace, smart contracts, etc.) so they can build additional services, dApps on top of our API and smart contracts.

A more detailed roadmap can be found below:

## 2021

- **Partnerships** – New IPs and Premium NFTs to be announced
- **Foundation** – Launch of the Foundation DAO with SAND staking for voting on Creators Fund management
- **Game Maker** – Official Release 1.0 and major updates with more gaming packages, Behaviors and Visual Scripting
- **Game** – Official Release 1.0 and major updates
- **LAND Public sale** – Regular LAND sales will continue
- **Events** – Additional Seasons with big rewards to earn
- **Multi-platforms** – Availability of Game on smartphones and tablets devices
- **Multiplayer** – First user-generated games with multiplayer modes
- **SAND** – Staking mechanisms for Yield generation and curation

## 2022

- **Partnerships** – New IPs and Premium NFTs to be announced



- **Games Platform** – Over 1,000 Games available
- **Multi-platforms** – Availability of Game on consoles
- **LAND Public sale** – Regular LAND sales will continue
- **Game Maker** – Co-Building Mode - creating games with Friends, Custom Scripting with programming 3rd layer and major updates with more gaming packages and Behaviors
- **Events** – Additional Seasons with big rewards to earn

## 2023

- **Games Platform** – Over 5,000 Games available
- **Partnerships** – New IPs and Premium NFTs to be announced
- **Game Maker** – Major updates with more gaming packages and behaviors added
- **Events** – Additional Seasons with big rewards to earn
- **DAO** – The Sandbox DAO will allow to participate in major decisions on the Game Platform

### 5.3. Major Features in the Press

- Our CEO, Arthur Madrid, published a Medium article titled Blockchain Metaverse: Where Players Can Build, Own, and Control a Platonic Republic of Gaming, which has been clapped over 500 times.

<https://medium.com/sandbox-game/blockchain-metaverse-where-players-can-build-own-and-control-a-platonic-republic-of-gaming-65e23f059e37>

- Our COO, Sebastien Borget, was quoted repeatedly on CoinTelegraph among 50 Crypto Experts on his perspectives for 2020 and looked back on 2019 articles.

<https://cointelegraph.com/explained/experts-share-what-are-the-biggest-crypto-and-blockchain-topics-to-follow-in-2020>

- The Sandbox ranked 13th among the Top 50 Blockchain Games Companies of 2020 report by DappRadar, while Animoca Brands is ranking 5th. This confirms our leadership position in the space.

- The Sandbox raises \$2 million more to build out blockchain-based game world from B Cryptos, True Global Ventures, Square Enix and more.

<https://venturebeat.com/2020/03/19/the-sandbox-raises-2-million-more-to-build-out-blockchain-based-game-world/>

- The Sandbox Virtual World sold out third Virtual Lands Presale generating 3,330 ETH/440,000 USD.

[https://www.gamasutra.com/view/pressreleases/360442/The\\_Sandbox\\_Virtual\\_World\\_sold\\_out\\_third\\_Virtual\\_Lands\\_Presale\\_after\\_6\\_Hours\\_generating\\_3330\\_ETH440000\\_USD\\_in\\_Atari\\_The\\_Park\\_Neighborhood.php](https://www.gamasutra.com/view/pressreleases/360442/The_Sandbox_Virtual_World_sold_out_third_Virtual_Lands_Presale_after_6_Hours_generating_3330_ETH440000_USD_in_Atari_The_Park_Neighborhood.php)

## 6. Platform

### 6.1. Gameplay Experience

The gaming experience on the new The Sandbox platform will be launched through several intermediary phases, with increasingly more complex features in each. When the alpha version is launched, players will be able to make transactions and store their digital voxel ASSETS while also playing and interacting with other voxel asset creators and players in different user generated worlds. The gaming experience will make The Sandbox a strong blockchain-based alternative to existing platforms such as Minecraft and Roblox.



Even for players who do not create discrete items to sell on the UGC store, the combination of creativity and security can pay off for players who create LANDS with compelling attractions. This is because a LAND might have different revenue streams implemented on it, like microtransactions. Additionally, players can play-to-earn by collecting rewards through gameplay.

We expect a wide variety of audiences to enjoy gaming experiences in The Sandbox marketplace. We have identified some of the types of games creators will be able to craft for them:

- **Social Experiences:** The ASSET marketplace will allow creators to fully decorate their spaces with beautiful sceneries and structures such as a fairy wonderland, a medieval town, or even a futuristic space station.

These types of experiences can attract communities of in-game friends that hang out for activities that combine social and gameplay elements.

- **Build & Craft:** Our voxel map is ideal for creators to make Building & Crafting experiences. Creators will be able to facilitate players with interesting experiences like building competitions, creating their own play spaces.

All these tools and mechanics will be able to interact with the terrain to modify it, build over it or even completely destroy it.

- **Exploration & Adventure:** Solve the mystery of the cursed swamp, slay the mercenary king of the endless desert, help the rebellion of the exiled prince of the elder LANDS or even discover all the hidden secrets of the ancient temple!

Creators will be able to bring narrative, exploration and adventure gameplay to their LAND. Each new LAND will be different, offering new potential to discover new LANDS, meet new people and discover never before seen secrets!

## 6.2. Map - LANDS

The persistent map determines a player's specific LAND coordinate. In most blockchain games where player domains are sold like real estate, the specific location of a domain is of paramount importance as it will determine who and what you are next to. Similarly, in The Sandbox there is a finite amount of LANDS, and their location is determined initially in the map, and cannot be moved from one coordinate of the world map to the other.

There are several advantages to this structure:

- Players have the agency to combine LANDS to create a bigger gaming space with and near their friends; and
- Friends can cooperate in the creation of these larger experiences by building experiences together within the combined LAND and thus sharing the rewards (whether financial or purely social or artistic).

There is also an economic incentive for players to work together via a combined LAND. For instance, if several players band together they can create a 'theme park' experience, with each member focusing on a key attraction, or members can focus on distinct neighborhoods that together create a 'city' experience. In each case, the team effort allows players to cooperatively create a stronger incentive for players to visit and enjoy their creations—and more visits results in more revenue to be shared.

It's true that a single player with one LAND can keep all the revenue from that LAND, but a larger, more diverse collection of LANDS combined can boost financial rewards to be shared by charging, for example, for a SUPER PASS that allows a player to visit all the gaming experiences in a combined LAND, with the revenue from the SUPER PASS shared between all the owners of said LAND.

There will be limits on joining LANDS together to keep certain conglomerations from having too much control and power against solo players.

Recent information has been released on The Sandbox [Transportation System](#).

## 6.3. ASSETS Marketplace

The marketplace will use smart contracts to control item auctions and transactions. This open marketplace for creators and developers will allow for the free trade of in-game assets between the platform users. Additional benefits of this marketplace are that economic principles of supply and demand become automatically integrated into the system, allowing the community to determine the fair price of user-generated ASSETS. The true strength of this marketplace, however, is that creators of such ASSETS can finally generate true tangible real-world value from the voxel content they create.

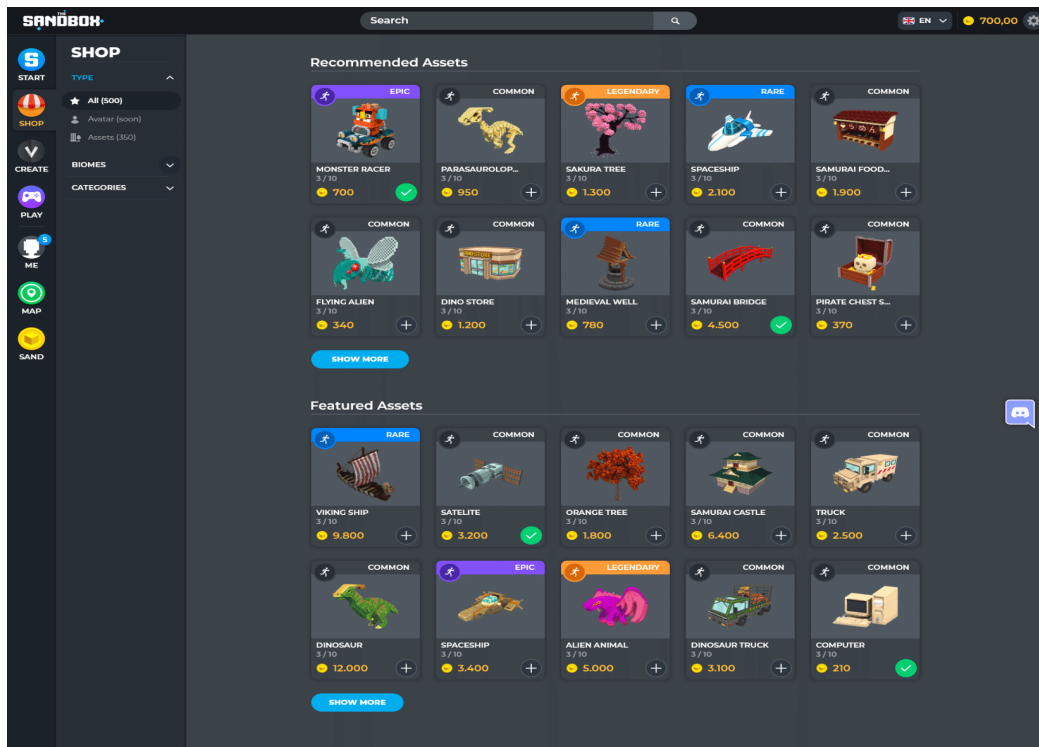

The ASSET tokens in our marketplace will require several pieces of information in order to properly be displayed as a sellable good. These pieces of info are:

- **Name & Genre:** In order to better identify the ASSET being sold, and to help potential buyers in finding it in the marketplace, the ASSET will require a name and a genre;
- **Description:** The description will help creators add specifications like size, model, potential uses or even attach a short piece of fictional lore to the ASSET;
- **Thumbnail:** The marketplace will show what the ASSET itself looks like via several thumbnails of the ASSET. We will include a feature in our voxel editor that will automatically generate these thumbnails for the creators;
- **Price:** The creator will have total control over the price the ASSET will have on the marketplace. This price will be set in SAND.
- **Value:** Creators will define Rarity, Scarcity and Attributes thanks to the [Gems & Catalysts](#) system.

Once all these requirements are met, the ASSET will be successfully displayed on the marketplace and be available for purchase.

## 6.4. VoxEdit

Under the philosophy of “CREATE, ANIMATE, PLAY” VoxEdit is the voxel modeling software that allows the artist to rig models and animate them using a user-friendly keyframe interpolation timeline.

- **Modeling:** Having other software that also lets you model your own voxel art – what makes the modeling in VoxEdit different is that it is aimed at artists. That commodity is thanks to a user-friendly interface, powerful tools to let the artists model anything they want, but also stay connected with them all the time to hear their feedback, what would be nice to have, and especially what would make their life using VoxEdit much easier.
- **Animation:** Here is where VoxEdit stands out. VoxEdit uses a skeletal system with hierarchies, like the ones used in professional 3D software like Maya, 3D Max, Cinema 4D, etc, allowing the Artist to rig anything they want and be ready for animation. It is the only voxel modeling software that allows to model AND animate your ASSETS.

Once the skeleton is made, the artist can create any type of animation moving the different parts of their model with an easy-to-use timeline. The timeline works like a video editing software timeline, using layers to represent what part of the model you are moving and creating key-frames to set the position, rotation and scale. The magic happens thanks to the interpolation of these key-frames that the timeline does in the background.

- **Exporting:**  
VoxEdit allows the artist to export their creation in .VXM and .VXR, formats that our Marketplace and games use to create a super smooth communication between the three parts. Besides that, it also lets export in the standard formats such as .OBJ and also .DAE and .GLTF for the models with animations on it.

## 7. Economy

We are excited by the opportunity to build new kinds of business models with this player-powered economy, both in terms of revenue model and token model.

SAND will provide immediate liquidity to players and investors. The valuation of the SAND token is calculated on what players will be able to build/play/trade/win inside our metaverse. We are aiming at replicating real-world economy systems, with players able to buy, rent, hire, vote, stake, etc.

The main flows of income will be the following:

- **Company ASSETS token:** Sales of ASSETS created and developed by the company (LANDS, ASSETS, Attributes, others);
- **Transaction Fees:** TSB to charges 5% of all transaction volume carried out in SAND tokens (Transaction Fees) to be allocated 50% to the Staking Pool as rewards for token holders that Stake SAND tokens and 50% to the "Foundation."
- **Player Subscription Fees:** Revenues that we will generate via various subscription models to gain access to exclusive in-game features, Premium ASSETS etc.

### 7.1. Tokenomics

SAND is the utility token used throughout The Sandbox ecosystem as the basis of transactions and interactions. It is an ERC-20 utility token built on the Ethereum blockchain. It will be used across the ecosystem by gamers, developers, and publishers, allowing Creators and Players to exchange ASSETS and Games and build a user-based platform of rewards while developing an ecosystem where Creators and Players will share various truly unique gaming experiences.

User generated digital ASSETS are represented as ERC-1155 tokens. To ensure the everlasting scarcity and verifiable scarcity of non-fungible items, we use the ERC-1155 token standard. This standard allows a smart contract to track token-ownership at the individual token level: each item has a unique identifier and, optionally, unique properties stored as metadata.

SAND can be used and acquired by Artists, Creators, Players and LAND Owners through multiple ways as described below:

	ARTISTS	CREATORS	PLAYERS	LAND OWNERS	INVESTORS
<b>What each profile will USE SAND tokens for?</b>					
<b>Year 1</b>	Mint ASSETS Buy Gems & Catalysts	Acquire ASSETS Publish Games Buy LANDS		Buy LANDS Combine LANDS in Estates	Acquire SAND on Exchanges
<b>Years 2-5</b>		Rent LANDS Create Prize Pools	Play Games Buy ASSETS, Avatar Skins & Equipments	Buy Portals	Stake SAND
<b>What each profile will GET SAND tokens with?</b>					

Year 1	Sell ASSETS Stake SAND	Event Rewards Stake SAND	Event Rewards Sell Gems & Catalysts Stake SAND in his LAND	Rent LANDS Sell LANDS Stake SAND in his LAND	Stake SAND
Years 2-5	Work For Hire	Monetize Games Work For Hire			

- **Players:**

**Playing:** Players will be able to earn SAND tokens while playing the different games uploaded to The Sandbox ecosystem. They might win SAND by slaying a legendary monster, opening a chest, or even completing a quest; nearly endless possibilities can be created in games;

**Skill-Based Challenge:** Players will be able to pay an entry fee to enter a challenge such as a race, a card game, a battle royale, or any other type of competitive contest. The winner takes all of the prize pool. The experience creator might take a % of the total pool for creating and hosting the experience; and

**Tips System:** A player who also happens to be a streamer, might be tipped with small amounts of SAND based on his performance either for entertaining his audience or by being good at whichever game he or she is playing.

- **Creators:**

**ASSET Sales Revenue:** Creators will be able to sell their assets in the marketplace, receiving 100% of the SAND price of the ASSET;

**In-Game Purchases:** Experience creators will be able to set up many different monetization systems that will let them charge players SAND for exclusive content. These monetization techniques range from item purchases to stat boosters, subscriptions, or even entry fees to the game itself;

**Creators Fund:** At the first stages of the ecosystem, we will have a rewards program to incentivize creators to fill the marketplace with amazing voxel creations and in return be rewarded with a generous sum of SAND tokens;

**Art Challenges:** We intend to keep a community-centered focus towards the marketplace, and with that in mind we decided that we will hold art challenges in which creators will be able to upload one of their ASSETS for the possibility to win a prize pool of SAND tokens if their ASSET received the most votes from the community; and



**Crowdfunded Requests:** We shall enable a section of the marketplace that allows individuals and groups of users to request a certain type of ASSET in exchange for a payment of SAND, contributed by all the requesters.

The flow of SAND within the ecosystem could be represented as follows:

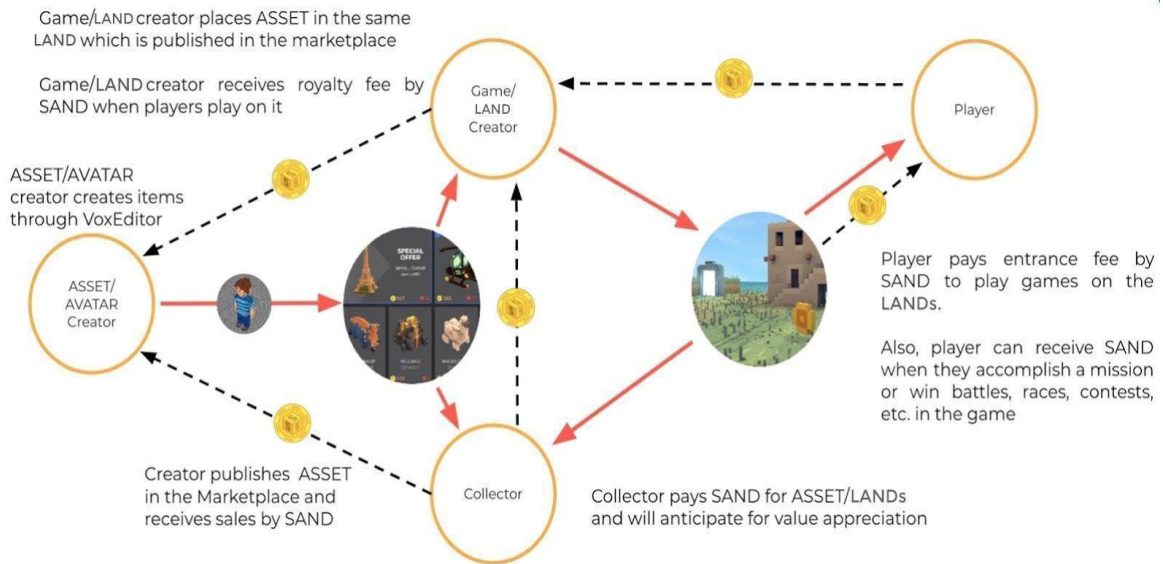

*What The Sandbox does and How*

## 7.2. Project Financing and Initial Revenue

During the period May 2019 to November 2019, the Company completed a successful private placement round with 13 Investors for an aggregate amount of USD 3,410,000. The private placement round was done through equity and token sale agreements:

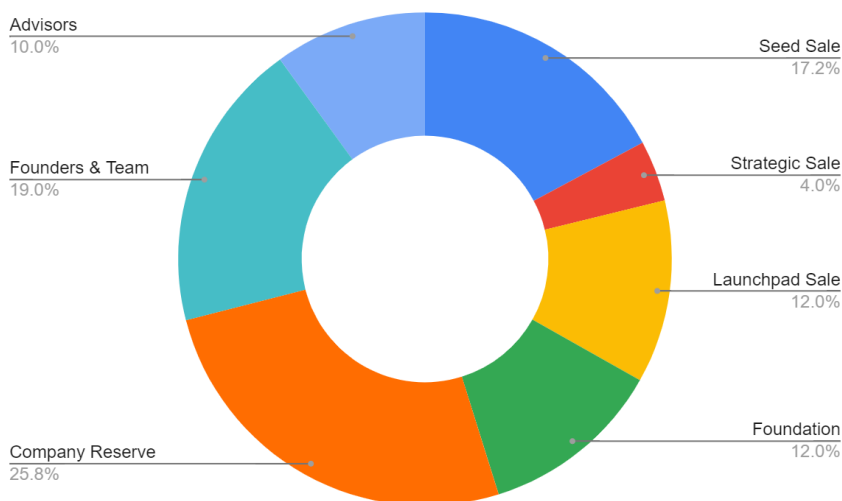

The token distribution and the SAND acquired by each investor during the private place took place in 2019 and resulted in the total sale of 515,277,777 SAND which is equivalent to 17.18% of the token allocation through token sale.

<b>Total SAND Supply</b>	<b>100.0%</b>	<b>3,000,000,000</b>
Seed Sale	17.18%	515,277,777
Strategic Sale	4.00%	120,000,000
Launchpad Sale	12.00%	360,000,000
Foundation	12.00%	360,000,000
Company Reserve	25.82%	774,722,223
Founders & Team	19.00%	570,000,000
Advisors	10.00%	300,000,000

SAND allocated to investors through the Private Sale, Founders, Tem and Advisors are 100% locked with 5 years vesting and 12-month cliff.

TSB has also generated its first LAND presales successfully during December 2019 and July 2020. All LAND assigned for sale have been sold for over 6,000 ETH.

## 7.3. Initial Exchange Offering

TSB is aiming to raise around USD 3,000,000 during the public sale, through the allocation of 12% of the total supply of SAND. There shall not be a soft cap and therefore there will be no refunds made of funds contributed towards the project and allocated as detailed below:

<b>Grow the development team and infrastructure for the game platform</b>	45%
<b>Marketing – Creators acquisition and IP licences for NFT developments</b>	45%
<b>Security, Legal and Compliance Expenses</b>	7%
<b>General and Administrative Expenses</b>	3%

Investors for SAND include, but are not limited to:

- Traditional Venture Capital;
- Cryptocurrency Investors;
- Gaming Companies;
- Gamers;
- Game Developers

## 7.4. Other Dynamics

As the community increases in terms of the number of creators, players and ASSETS in the marketplace, there will be an increase in the need for a utility token to reward the growing number of stakeholders participating in the platform.

- **Growth Model and KPIs**

The key success factors for building the ecosystem consist of ensuring an organic community growth of Creators and Players invested in the value proposition offered by The Sandbox while ensuring customer satisfaction. In order to ensure a progressive growth of the community and its model, we have identified key variables that will be measured and incentivized through marketing, promotional, and communication tactics to ensure the growth of the ecosystem:

- Creators growth rate;
- Players growth rate;
- New Assets created and uploaded per Creator;
- New Assets created and uploaded by TSB;
- Assets sold per month created by Creators;
- Assets sold per month created by TSB;
- Inflation rate of Assets in the marketplace;
- Average price per Asset developed by Creators (in SAND);
- Average price per Asset developed by TSB (in SAND);
- Asset price growth;
- Initial supply of SAND;
- Initial supply of SAND in the hands of Creators and Players;
- Price of SAND (in USD or ETH);
- % Commission at the marketplace.

Therefore, while the total supply of SAND is fixed, the initial amount of SAND offered to the ecosystem through creators and players will be limited to add a scarcity effect due to the following key factors:

- A growing number of Creators and Players which eventually will reduce the SAND available per capita; and
- Staking effect, increasing the time holding SAND.

## 8. Technology

Blockchain technology is used to record ownership of tokens and allow owners to transfer/sell/use them without restriction. IPFS is used to store the actual digital asset and ensure the asset cannot be changed without owner permission.

Three different blockchain protocols will be integrated into The Sandbox gaming stack:

- **ERC-20** for SAND; and
- **ERC-1155 and ERC-721** for the Digital Assets storage and trading.

### 8.1. Future Technology Integrations

Why are we using Ethereum? We found many benefits to do so as detailed below:

- **Ease of use:** Ethereum has been built with flexibility in mind, which perfectly fits our use case with Asset tokens. Ethereum also has the largest number of developers, which allows for well-established standards, best practices and support;
- **Robustness:** It is, as of today, among the most robust blockchain protocols: its wide adoption makes the network validated by many and thus more secure; and
- **Interoperability:** Ethereum is a protocol, a base layer on top of which all applications can build and interact with each other.

The main issue faced by Ethereum today is often said to be its scaling issue. Blockchains are based on three pillars: Security, Decentralization and Scalability (throughput). Historically, Ethereum always put security and decentralization first, at the cost of scalability and some technological improvements need to be made at the base layer to support traffic at scale. On most public blockchains like Ethereum, this is one of the main current concerns, and lots of efforts are in progress to solve those scaling issues, without sacrificing the blockchain trilemma.

Ethereum is a blockchain that has been proven by thousands of dApps and developers for its robustness and offering a large ecosystem, resources and support from developers. With the current system we are building, escrow less auctions, meta transaction, subscriptions (&cie) we can offer a great experience on Ethereum for non-crypto users

The Sandbox team is looking at layer-2 solutions (that use the main ethereum chain as an anchor for security) – at the moment they are not yet ready for implementation or have not reached a production stage so that we could reliably integrate them. We will closely follow technical progresses on this topic and decide to integrate the solution that combines the best advantages for our product, use-case and users.

## 8.2. Multiple Class Fungible Token (MCFT)

At The Sandbox, we spend a lot of time looking at how to preserve security and integrity for ASSETS on the blockchain while still allowing the speed and flexibility that players and creators demand. As with many aspects of game design, you can't get everything you want easily, so it's a matter of balancing elements to implement the best solution

The ERC-1155 standard that we co-created with other game companies in the blockchain space, was designed to support the management of millions of tokens. On top of that our ASSET contract is also ERC-721 compliant and allows multiple unique items to be created by a single smart contract with the benefit of keeping the ERC-721 interface to allow interoperability with other Marketplaces and games

In The Sandbox, users will have full control over their ASSETS, by being able to create them, but also having the possibility to buy, sell, and trade those same ASSETS in The Sandbox Marketplace using our SAND token currency.

### 8.2.1. Interoperability

As we use Ethereum as the substrate of our ERC-1155/ERC721 implementation, any platform / wallet that supports ERC-1155/ERC-721 will be able to inspect and use our ASSET. This means independent developers could rely on the plethora of ASSETS our players will be creating.

The Sandbox gaming environment will be divided into 5 types of tokens:

- SAND (our game currency used across the system)
- LANDS (Worlds in which players play that are created by the community)
- ASSETS (Voxel models created by players and traded in the marketplace)
- GEMS burnt to give attributes to ASSETS. They are ERC20 tokens
- CATALYSTS burnt to mint ASSETS. Depending on their power, they allow users to associate a certain number of GEMS to an ASSET. They are ERC20 tokens

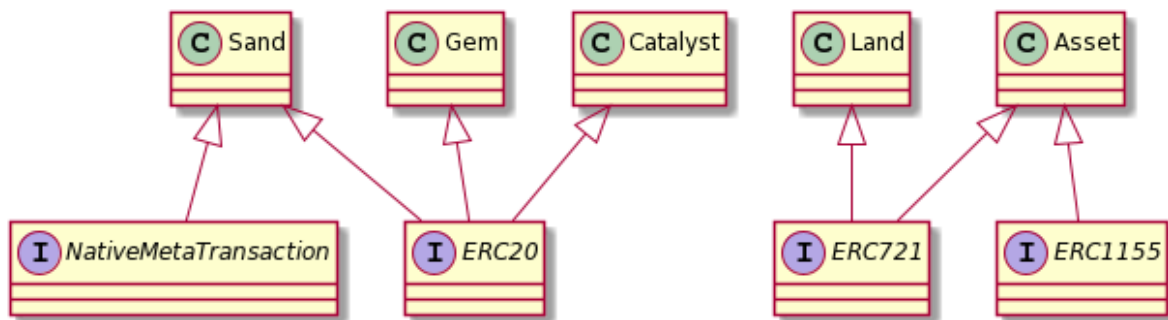

**Figure: The Sandbox Tokens**

Token contracts are responsible for:

- Keeping track of creator (the address that minted the token)
- ownership
- transfers
- Emitting events when the state changes

### 8.2.2. Meta Transactions

The Sandbox is aiming to bring non-crypto users to the blockchain world. In order to achieve that we believe that the system should be transparent to the user as much as possible.

Meta Transactions allow users that own SAND to interact with our platform without the need to own or know what ETH is or for that matter any of the tokens that will be used.

## 8.3. Technology Solution Breakdown

The Sandbox platform architecture is composed of several components. In terms of blockchain integration, we have a traditionally backend running on the cloud (currently using AWS) to support our web frontend. An S3 bucket is used to store the asset of the artist before they get minted. While we currently guarantee the privacy of the artist work (to protect their work from being copied prior to minting), we envision later a system that would prevent even us to peek at the artist work pre-minting.

Once an UGC asset is minted, our backend releases the ASSET on IPFS so that it becomes public. Our smart contract records the hash of an ASSET so that the owner of the ASSET will always be able to prove ownership of not only the number recorded on the blockchain (which many projects in the blockchain gaming space stop there) but also the voxel model itself as well as the various render.

Here is an overview of the overall architecture with all components represented.

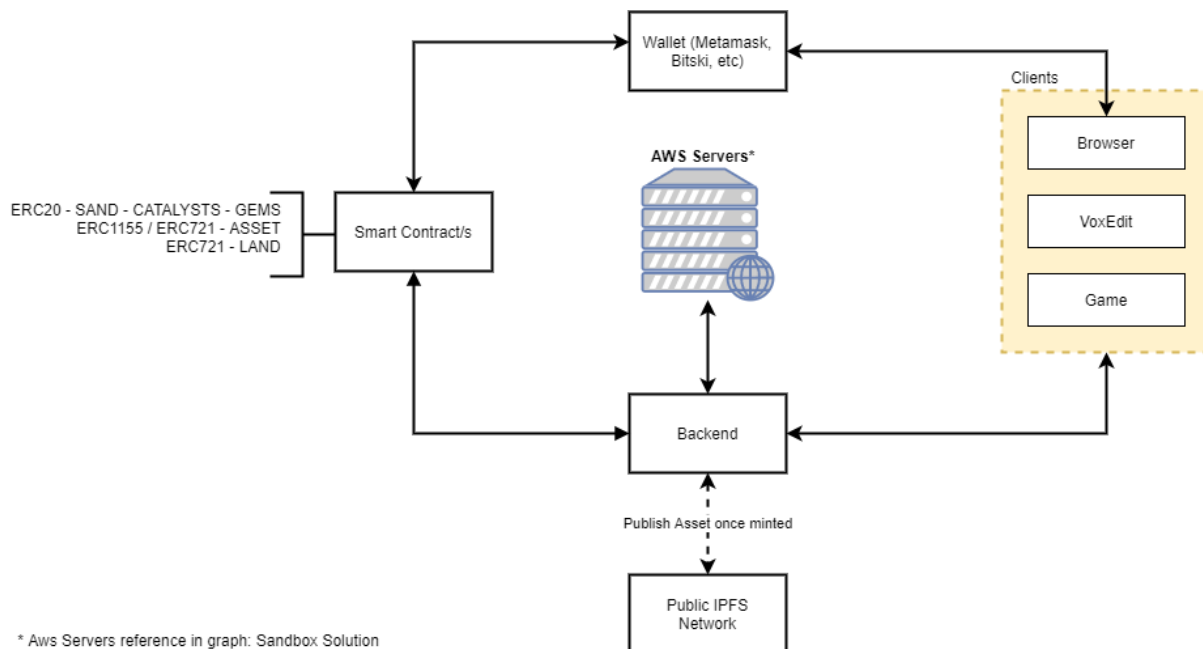

- Creators can create their ASSETS with VoxEdit, and upload those ASSETS through the browser
- Metamask is a web3 provider which acts as an intermediary between the User and the blockchain
- A browser in which the user will interact with the smart contracts and our server
- The smart contracts running on the blockchain
- Our server currently hosted on AWS
- The backend is being developed with Node.js, which manages the creation of an asset on S3, generating a Hash ID for that ASSET, which is sent back to the frontend so it can begin the transaction with the smart contract.
- Finally, once the transaction is confirmed we released the asset on the ipds network. ensuring that future owner will always be able to prove that what graphical representation they hold is indeed the original one.

**IPFS<sup>17</sup>** (The InterPlanetary File System) is a peer-to-peer distributed file system that seeks to connect all computing devices with the same system of files.

### 8.4. Program Agents

The Sandbox platform architecture includes a server on our AWS infrastructure that is monitoring the blockchain and registering change of state.

Changes are then propagated by our API into our backend, and our centralized database is updating its records, so that the frontend can pull the recent changes and display them accordingly to the players and users of The Sandbox platforms.

These changes of states include transfer of ownerships from the tokens (LANDS, ASSETS, or SAND).

Additionally, the following are the various situations that will trigger external data inputs to our smart contracts. The data received in inputs is always sanitized and several security layers are implemented to make sure these are protected. Our smart contracts have been duly audited.

- **LAND Sale Setup:** we submit the LAND configuration to each new sale contract at the time of deployment.
- **LAND Sale:** the buyer submits their LAND of choice inclusive of the payment, following which the contract mints the LAND in exchange. We provide a 2D map to allow the buyer to easily choose their LAND;
- **LAND Sale Stable Price Oracle:** We do not have any oracle system that sends information to our smart contract. Instead we utilise MakerDAO medianizer which receives updates from the Oracle and makes a median estimation of the price of the dollar: <https://developer.makerdao.com/feeds/>
- **Asset Sale setup:**
  - the creator submits a 3D voxel model to our backend, we hash the result and submit that on the smart contract, that in turn mints a token to represent it;
  - the creator submits a signature specifying the selling price and our backend shall store it;
- **Asset Sale:** the buyer submits a payment for a particular token to the smart contract along with the seller signature. It receives the token in exchange.

## 8.5. Game Engine

We have developed a custom Voxel Engine on top of Unity engine.

Our engine leverages the power of the new Unity Data Oriented Tech Stack (a.k.a. DOTs) by making extensive use of the Entity Component System (ECS) and the Jobs system.

By using Unity's new Universal Render Pipeline (URP) we are able to support Mobile platforms in the future, without sacrificing the render quality of our game for Desktop platforms.

Our engine also implements support for our custom Voxel Models, Rigging and Animation formats (VXM, VXR, VXA) from our in-house Voxel Editor (VoxEdit).



## 8.6. Wallets

We minimize the security risk on our backend by reducing the responsibility of hot wallets that are only used for referral and whitelisting.

The other wallets are cold storage wallets that hold responsibility for updating the platform with new contracts and new parameters. These could later be part of a governance mechanism.

For these cold wallets, we use a 2 out of 3 multi-signature wallet (<https://github.com/gnosis/MultiSigWallet>) and all of the owners of those multi-signatures are three hardware wallets.

This wallet has the possibility to upgrade our SAND token, as well as the ability to extend functionality via super operators.

In relation to the methods of payment, if the user wishes to pay with:

- an ERC-20 based token (ETH or DAI), it will then be processed by a smart contract on-chain and the user shall receive the SAND directly into his wallet; and/or
- BTC, credit card or fiat payment, it will then be processed by a third party service merchant solution, whereby upon confirmation by the latter, the SAND shall be released.

## 8.7. Security

The Sandbox marketplace is relying on the security of Ethereum for the functioning of its smart contracts. The only wallet that can affect the logic of our smart contract is our multi-signature wallet which uses the gnosis MultiSig wallet backed with three hardware wallets.

On our backend side, we manage a database that cache the smart contract events to keep track of ownership. Our backend also stores temporary assets. On that side, its responsibility is thus minimal.

As for fiat payment hot wallet, we are designing a daily auto-refill to ensure that only a minimum amount of token is present, minimizing the consequence of a breach.

## 9. The Team

We have assembled the right senior team to execute our vision: 42 resources located in our 3 offices with 28 full time employees in Argentina, 11 in France, 2 in Korean and 1 in Japan.

### 9.1. Core Team

#### **Arthur Madrid** - CEO and Director of The Sandbox

Arthur Madrid is the Co-founder and CEO of Pixowl (acquired by Animoca Brands in 2018) as well as The Sandbox (40M players). Board Member of Animoca Brands and a longtime social-gaming entrepreneur. He sold two software companies (Wixi Inc. and 1-Click Media) and is an advisor for startups in gaming, social media and software. Arthur began his career building a P2P delivery platform for Media companies, one of the first Distributed Computing Software (DCIA) platforms. Now, he is focusing on Blockchain Gaming as CEO & Co-Founder of The Sandbox.

#### **Sebastien Borget** – COO and Director of The Sandbox

Sébastien Borget is the Co-founder and COO of Pixowl (acquired by Animoca Brands in 2018) as well as The Sandbox (40M players). Passionate for blockchain technology, gaming and education, he is a very active speaker and evangelist on the opportunity Non-Fungible Tokens brings to gaming. He is now building the metaverse with The Sandbox, one of the 2019's most anticipated and top ranked blockchain games (#13 in the Top 50), that is empowering players through NFTs, enabling them to own, buy, sell and trade their 3D creations on their Marketplace and use them in their Game Maker. Sebastien also became President of the Blockchain Game Alliance in 2020.

#### **Marcelo Santurio** - CFO of The Sandbox

Marcelo Santurio is the Co-founder of the 1st online payment company in Latam and has +20 years experience in Finance, Tech, and Gaming. MBA from the London Business School with focus on Finance and Execute Program at MIT in Entrepreneurship.

#### **Pablo Iglesias** - Inventor of The Sandbox Game

Pablo Iglesias has over ten years of experience in researching and developing emergent procedural systems while leading teams of professionals through several successful games.

#### **Lucas Shrewsbury** - CTO of The Sandbox, ex-CTO of Gameloft

Lucas Shrewsbury has spent more than a decade leading mobile gaming studios. While at Gameloft Argentina, he managed the studio and a team of 200 people.

## 9.2. Advisors

<b>Hashed</b>	Based in South Korea and San Francisco, Hashed has realized meaningful gains in the crypto-industry. Led by serial entrepreneurs and engineers, Hashed has expedited global Blockchain adoption through strategic investment and community building.
<b>Mikhael Naayem</b>	Mik Naayem is Chief Business Officer at Axiom Zen and CryptoKitties, the world's most successful game built on blockchain technology and Axiom Zen's first public blockchain project. Mik focuses on directing business strategy, growing partnerships, and evolving the company platform.
<b>Yat Siu</b>	Co-founder and CEO at Animoca Brands. He is a serial entrepreneur and angel investor. He is the CEO and founder of Outblaze (sold B2B business to IBM in 2009) and he has received recognition for his role as an entrepreneur focused on Internet and technology companies.
<b>Alexis Bonte</b>	Group COO of Stillfront Group, Co-founder and board member of eRepublik Labs. He is a co-founder and angel investor with a strong general management background and over 20 years 360 degrees experience in all types of start ups from early stage to post-IPO.
<b>Ed Fries</b>	Ed Fries created his first video games for the Atari 800 in the early 1980s. He joined Microsoft in 1986, and spent the next ten years as one of the early developers of Excel and Word. He left the Office team to pursue his passion for interactive entertainment and created Microsoft Game Studios. Over the next eight years he grew the team from 50 people to over 1200, published more than 100 games including more than a dozen million+ sellers, co-founded the Xbox project, and made Microsoft one of the leaders in the video game business.

## 9.3. Services Providers

<b>Legal, Accounts &amp; Tax</b>	<b>Centrium Advisory</b>
<b>System Auditor(s)</b>	Fact Group Certik Solidified

## CONCLUSION

The Sandbox decentralized platform allows players and creators to own a piece of our gaming metaverse (LAND), participate in the governance and economy (SAND), while creating and enjoying a simple way to benefit from their playing time.

In the coming year, our experienced and dedicated team will build an unique way to play in a virtual world where you can play, create, collect, earn, govern, and own anything in the game.

Join us now.